

REV.	DESCRIPTION	DRAWN	CHECKED	APPROVED
A	NEW RELEASE	WPY 03/06/26'		



Notes:

Specifications:

- 1.Contact Resistance:25mQ Max.
- 2.Insulation Resistance:1000MΩ Min.
- 3.Dielectric Withstanding Voltage:
1000V AC(rms) For 1 Minute.
- 4.Current Rating:8A max.
- 5.Voltage Rating:250V max.
- 6.Temperature:-25°C~+85°C.
- 7.Box Size:19.5*13*3.6CM

Materials:

1.Insulating material:PA66.

Product Number Code:

DS1148-07-BOX-01

GENERAL TOLERANCE		ANGLE TOLERANCE		PROJECTION		TITLE	380PCS 2.8mm Automotive An Motorcycle-Electrical Wire Connector		
X.	±0.30	X.	±2°	UNITS	mm	SHEET SIZE	A4		
.X	±0.20	.X	±1°			SERIES	DS1148-07 Series		
.XX	±0.15	.XX	±0.5°						
DRAWING TYPE		CUSTOMER DRAWING		晨翔电子有限公司 CONNFLY CONNFLY ELECTRONIC CO. LTD					
SCALE		1:1	SHEET			1 OF 3			
DRAWING NO.		C-DS1148-07-BOX-01-A							

REV.	DESCRIPTION	DRAWN	CHECKED	APPROVED
A	NEW RELEASE	WPY 03/06/26'		

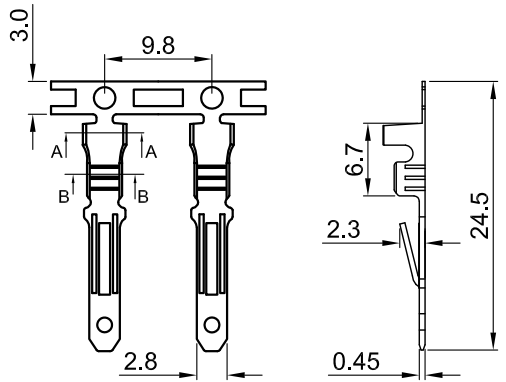
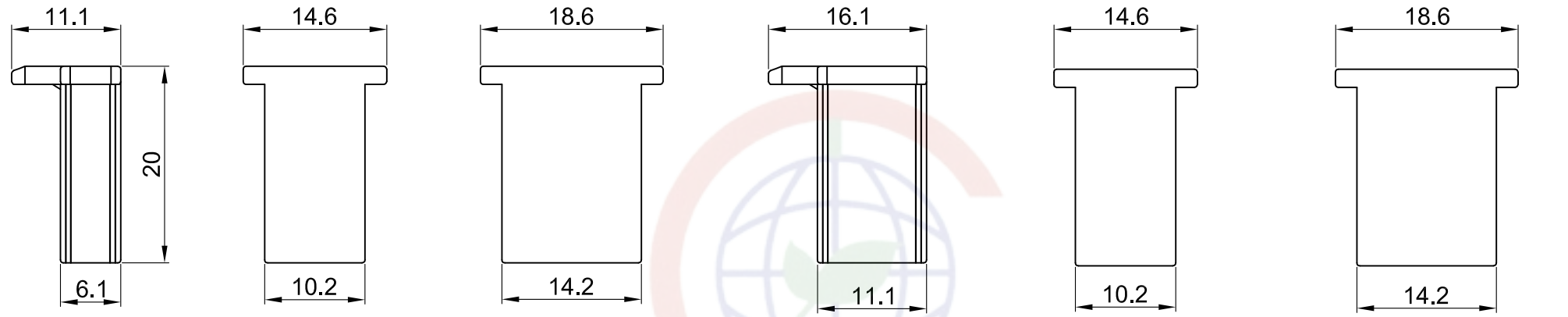

GENERAL TOLERANCE		ANGLE TOLERANCE	
X.	±0.30	X.	±2°
.X	±0.20	.X	±1°
.XX	±0.15	.XX	±0.5°

PROJECTION		TITLE	2.8mm Automotive An Motorcycle-Electrical Wire Connector
UNITS	mm	SERIES	DS1148-07 Series
SHEET SIZE	A4		

DRAWING TYPE	CUSTOMER DRAWING		
SCALE	1:1	SHEET	2 OF 3
DRAWING NO.	C-DS1148-07-BOX-01-A		

晨翔电子有限公司
CONNFLY CONNFLY ELECTRONIC CO. LTD

REV.	DESCRIPTION	DRAWN	CHECKED	APPROVED
A	NEW RELEASE	WPY 03/06/26'		

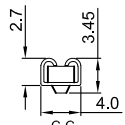
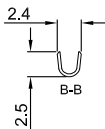
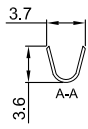
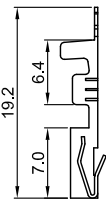
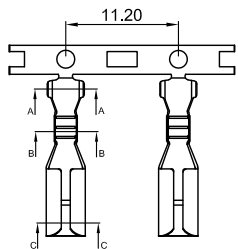
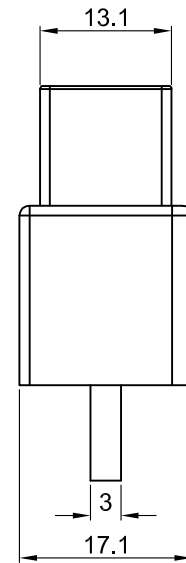
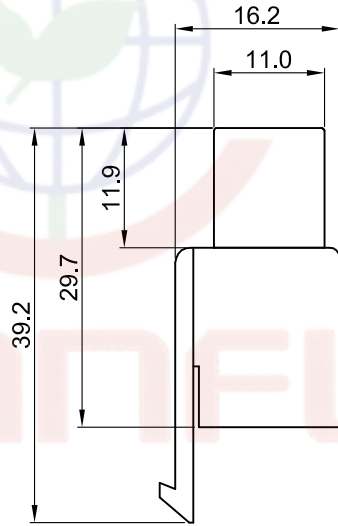
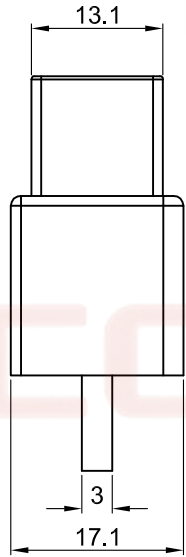
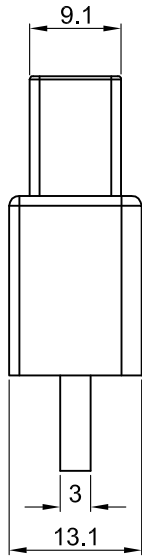
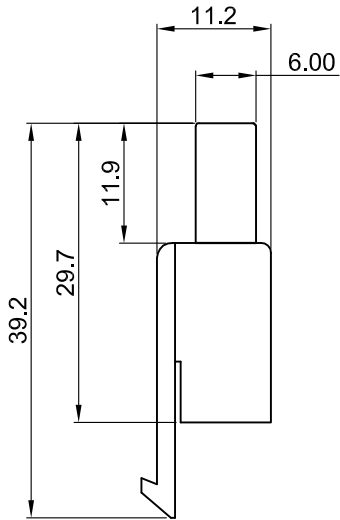
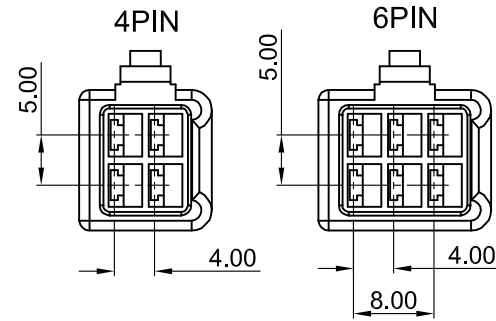
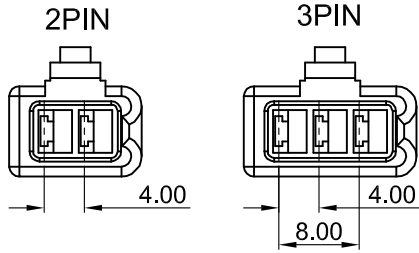

GENERAL TOLERANCE		ANGLE TOLERANCE	
X.	±0.30	X.	±2°
.X	±0.20	.X	±1°
.XX	±0.15	.XX	±0.5°

PROJECTION	TITLE
	2.8mm Automotive An Motorcycle-Electrical Wire Connector
UNITS	mm
SHEET SIZE	A4
SERIES	DS1148-07 Series

DRAWING TYPE	CUSTOMER DRAWING
SCALE	1:1 SHEET 3 OF 3
DRAWING NO.	C-DS1148-07-BOX-01-A

晨翔电子有限公司
CONNFly CONNFly ELECTRONIC CO. LTD