

The information provided herein is from CONNELY Electronic Co., Ltd. and is confidential. Any disclosure to a party other than the recipient is prohibited. The intellectual properties and its rights contained herein, including but not limited to, trademarks, patents, copyrights, trade secrets, and technical know-how, are owned exclusively by CONNELY or its affiliates. Unauthorized use or reproduction of any part of this document is strictly prohibited. CONNELY may enforce its intellectual property rights at its own discretion, failures or delays to exercise such rights does not constitute a waiver of such rights.

REV.	DESCRIPTION	DRAWN	CHECKED	APPROVED
A	NEW RELEASE	JLZ 01/18/21'		
B	DRAWING UPDATE	JLZ 11/04/22'		

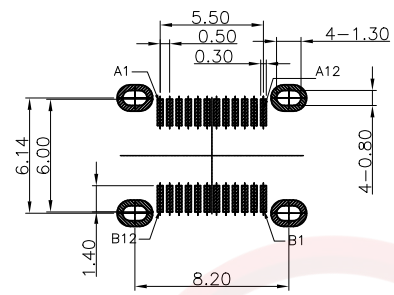

RECOMMEND P.C.B LAYOUT(COMPONENT SIDE)
TOLERANCE FOR PCB LAYOUT IS ± 0.05
KEEP OUT AREA

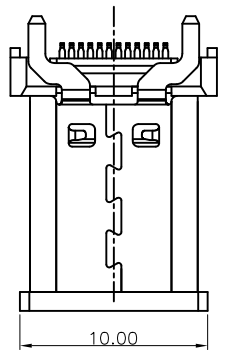
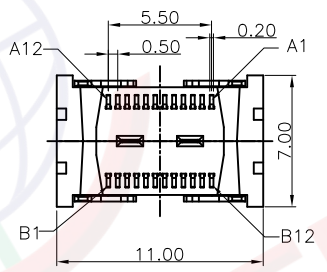
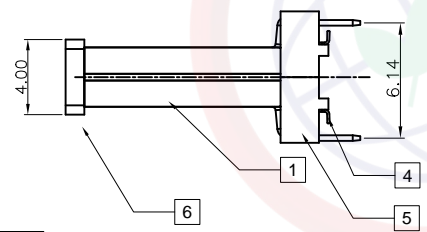
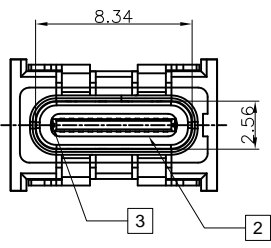

- NOTE:
- Contact Resistance:40mOHM Max.;
 - Dielectric Withstanding Voltage:100V AC For 1 Minute;
 - Insulation Resistance:100M OHM Min.;
 - Mating And Unmating Force:
Mating Force: 5~20N
Unmating Force: 8~20N(0~1000cycle);
6~20N(1001~10000cycle);
 - Durability:10000 Cycles;
 - Product number code:
DS1144-40 - X X X X X X X

- Packing Type
R: Tape On Reel
- Shell Plating
N: Full Nickel
- Housing color
B: Black
- Contact Plating
0: Selective gold flash
5: Selective 15u" gold
- Mounting type
S: SMT type
- Connector type
F: Female
- No. of contacts
24: 24pin

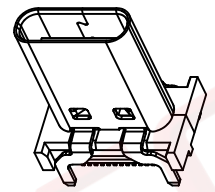
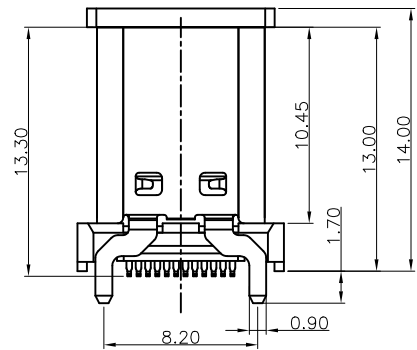

WITHOUT COVER

USB TYPE-C PIN ASSIGNMENTS

PIN NUMBER	SIGNAL NAME	PIN NUMBER	SIGNAL NAME
A1	GND	B12	GND
A2	TX1+	B11	RX1+
A3	TX1-	B10	RX1-
A4	Vbus	B9	Vbus
A5	CC1	B8	SBU2
A6	D+	B7	D-
A7	D-	B6	D+
A8	SBU1	B5	CC2
A9	Vbus	B4	Vbus
A10	RX2-	B3	TX2-
A11	RX2+	B2	TX2+
A12	GND	B1	GND

Item	Title	Material	Dispose	Q' TY
1	Shell	SUS304	Ni:30u" Min.	1PCS
2	GND Plate	SUS301		2PCS
3	Mid Plate	SUS301		1PCS
4	Contact	C7025	Mating Area: See P/N Solder Tails: Matt Tin	2PCS
5	InsertMolding	LCP E6808	UL 94V-0 Black	1PCS
6	COVER	LCP E6808	UL 94V-0 Black	1PCS



(Series Image-Reference Only)

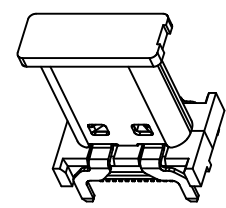

WITH COVER

GENERAL TOLERANCE	ANGLE TOLERANCE	PROJECTION	TITLE	USB C Type 24P Female V/T SMT Type H=13.0mm	
X. ±0.60	X. ±5°	UNITS	mm	SHEET SIZE	A4
.X ±0.38	.X ±3°	SHEET SIZE	A4	SERIES	DS1144-40 SERIES
.XX ±0.25	.XX ±2°	晨翔电子有限公司 CONNFLY CONNFLY ELECTRONIC CO. LTD			
DRAWING TYPE	CUSTOMER				
SCALE	1:1				
DRAWING NO.	C-DS1144-40-XXXXXX-B				