

Dept	
Qty	
DC	1
ED	1
IE	1
ISO	1
PD	1
R&D	1
SD	1
QA	1
QC	1
QE	1

The information provided herein is from CONNFLY Electronic Co., Ltd. and is confidential. Any disclosure to a party other than the recipient is prohibited. The intellectual properties and its rights of CONNFLY Electronic Co., Ltd. are strictly protected. Any modification is strictly prohibited without prior written consent from CONNFLY. All intellectual properties provided herein are for reference purposes only and does not constitute authorization of its use in any format or manner. CONNFLY may enforce its intellectual property rights at its own discretion; failures or delays to exercise such rights does not constitute a waiver of such rights.

REV.	DESCRIPTION	DRAWN	CHECKED	APPROVED
A	NEW RELEASE	WPY 02/08/25'		

Docking type

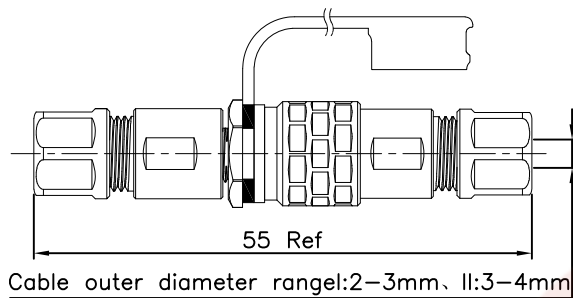

Male

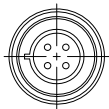

Female

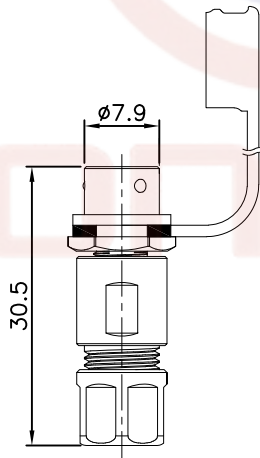
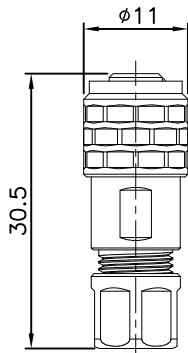

Note:

Specifications:

1. Rated voltage: 30V
2. Rated current: 3A
3. Contact resistance: 10mΩ
4. Withstand voltage: 500V
5. Operating temperature: -40°C to +85°C
6. Wiring method: Solder

Materials:

1. Shell material: Brass with chrome plating
2. Insulation material: PPS  
High temperature resistance 260°C
3. IP rating: IP67
4. Contact material: Brass with gold plating

Product Number Code:

DS1110-62-X X X X X X

- Install Type:  
A: Docking type
- Cable diameter:  
1: 2-3mm 2: 3-4mm
- Contact Plating:  
8: Gold flash
- Color of shell:  
S: Silvery
- Color of housing:  
B: Black
- No. of Contacts:  
2 3 4 5

GENERAL TOLERANCE		ANGLE TOLERANCE	
X.	±0.60	X.	±5°
.X	±0.38	.X	±3°
.XX	±0.25	.XX	±2°
DRAWING TYPE		CUSTOMER	
SCALE	1:1	SHEET	1 OF 4
DRAWING NO.	C-DS1110-62-XXXXXX-A		

PROJECTION		TITLE	6mm push-in fast locking aviation plug (Copper chrome plating)
UNITS	mm	SERIES	DS1110-62 Series
SHEET SIZE	A4		

晨翔电子有限公司  
CONNFLY CONNFLY ELECTRONIC CO. LTD

Dept	
Qty	
DC	1
ED	1
IE	1
ISO	1
PD	1
R&D	1
SD	1
QA	1
QC	1
QE	1

The information provided herein is from CONNELY Electronic Co., Ltd. and is confidential. Any disclosure to a party other than the recipient is prohibited. The intellectual properties and its rights of CONNELY Electronic Co., Ltd. are strictly protected. All intellectual properties provided herein are for reference purposes only and does not constitute authorization of its use in any format or manner. CONNELY may enforce its intellectual property rights at its own discretion; failures or delays to exercise such rights does not constitute a waiver of such rights.

REV.	DESCRIPTION	DRAWN	CHECKED	APPROVED
A	NEW RELEASE	WPY 02/08/25'		

Rear nut type

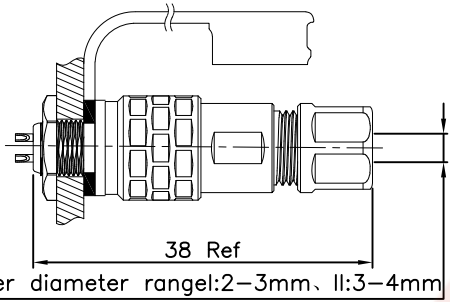

Male

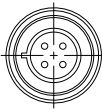

Female

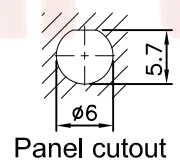
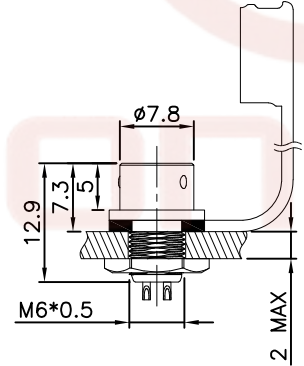
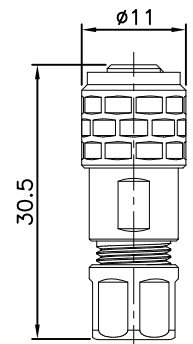
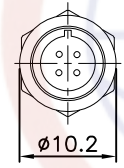

Note:

Specifications:

1. Rated voltage: 30V
2. Rated current: 3A
3. Contact resistance: 10mΩ
4. Withstand voltage: 500V
5. Operating temperature: -40°C to +85°C
6. Wiring method: Solder

Materials:

1. Shell material: Brass with chrome plating
2. Insulation material: PPS  
High temperature resistance 260°C
3. IP rating: IP67
4. Contact material: Brass with gold plating

Product Number Code:

DS1110-62-X X X X X X

- Install Type:  
B: Rear nut type
- Cable diameter:  
1: 2-3mm 2: 3-4mm
- Contact Plating:  
8: Gold flash
- Color of shell:  
S: Silvery
- Color of housing:  
B: Black
- No. of Contacts:  
2 3 4 5



GENERAL TOLERANCE	ANGLE TOLERANCE
X. ±0.60	X. ±5°
.X ±0.38	.X ±3°
.XX ±0.25	.XX ±2°

PROJECTION		TITLE	6mm push-in fast locking aviation plug (Copper chrome plating)
UNITS	mm	SHEET	2 OF 4
SHEET SIZE	A4	SERIES	DS1110-62 Series

DRAWING TYPE	CUSTOMER
SCALE	1:1
DRAWING NO.	C-DS1110-62-XXXXXX-A

晨翔电子有限公司

CONNELY CONNELY ELECTRONIC CO. LTD

Dept	
Qty	
DC	1
ED	1
IE	1
ISO	1
PD	1
R&D	1
SD	1
QA	1
QC	1
QE	1

The information provided herein is from CONNFLY Electronic Co., Ltd. and is confidential. Any disclosure to a party other than the recipient is prohibited. The intellectual properties and its rights of CONNFLY Electronic Co., Ltd. are strictly protected. All intellectual properties provided herein are for reference purposes only and does not constitute authorization of its use in any format or manner. CONNFLY may enforce its intellectual property rights at its own discretion; failures or delays to exercise such rights does not constitute a waiver of such rights.

REV.	DESCRIPTION	DRAWN	CHECKED	APPROVED
A	NEW RELEASE	WPY 02/08/25'		

Front nut type

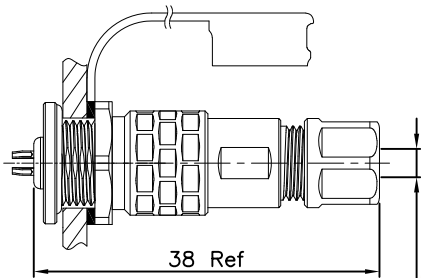

Cable outer diameter rangel:2-3mm, II:3-4mm

Male

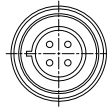

Female

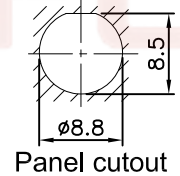
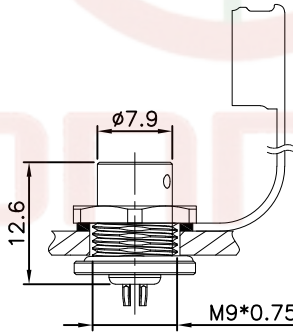
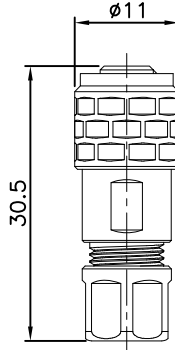
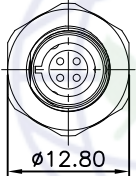

Note:

Specifications:

1. Rated voltage:30V
2. Rated current:3A
3. Contact resistance:10mΩ
4. Withstand voltage:500V
5. Operating temperature: -40°C to +85°C
6. Wiring method: Solder

Materials:

1. Shell material: Brass with chrome plating
2. Insulation material: PPS  
High temperature resistance 260°C
3. IP rating:IP67
4. Contact material: Brass with gold plating

Product Number Code:

DS1110-62-X X X X X X

- Install Type:  
C:Front nut type
- Cable diameter:  
1:2-3mm 2:3-4mm
- Contact Plating:  
8:Gold flash
- Color of shell:  
S:Silvery
- Color of housing:  
B:Black
- No.of Contacts:  
2 3 4 5



GENERAL TOLERANCE	ANGLE TOLERANCE
X. ±0.60	X. ±5°
.X ±0.38	.X ±3°
.XX ±0.25	.XX ±2°

PROJECTION		TITLE	6mm push-in fast locking aviation plug (Copper chrome plating)
UNITS	mm	SHEET SIZE	A4
SHEET SIZE	A4	SERIES	DS1110-62 Series

DRAWING TYPE	CUSTOMER
SCALE	1:1 SHEET 3 OF 4
DRAWING NO.	C-DS1110-62-XXXXXX-A

晨翔电子有限公司  
CONNFLY CONNFLY ELECTRONIC CO. LTD

Dept  
Qty

DC 1  
ED 1  
IE 1  
ISO 1  
PD 1  
R&D 1  
SD 1  
QA 1  
QC 1  
QE 1

The information provided herein is from CONNELY Electronic Co., Ltd. and is confidential. Any disclosure to a party other than the recipient is prohibited. The intellectual properties and its rights of CONNELY Electronic Co., Ltd. are strictly protected. All intellectual properties provided herein are for reference purposes only and does not constitute authorization of its use in any format or manner. CONNELY may enforce its intellectual property rights at its own discretion; failures or delays to exercise such rights does not constitute a waiver of such rights.

REV.	DESCRIPTION	DRAWN	CHECKED	APPROVED
A	NEW RELEASE	WPY 02/08/25'		

# Solder contact arrangement and spec

No.of Contacts	2	3	4	5
Male contact face view				
Rated current (A)	3	3	3	3
Contact diameter(mm)	Ø0.6×2	Ø0.6×3	Ø0.6×4	Ø0.6×5
Rated Voltage (AC.V)	30	30	30	30
Test voltage(AC.V) 1 min	500	500	500	500
Contact resistance(mΩ)	10	10	10	10
Wiring method(mm <sup>2</sup> /AWG)	≤0.5/20	≤0.5/20	≤0.5/20	≤0.5/20

GENERAL TOLERANCE		ANGLE TOLERANCE	
X.	±0.60	X.	±5°
.X	±0.38	.X	±3°
.XX	±0.25	.XX	±2°
DRAWING TYPE		CUSTOMER	
SCALE	1:1	SHEET	4 OF 4
DRAWING NO.	C-DS1110-62-XXXXXX-A		

PROJECTION		TITLE	6mm push-in fast locking aviation plug (Copper chrome plating)
UNITS	mm	SHEET	4 OF 4
SHEET SIZE	A4	SERIES	DS1110-62 Series

晨翔电子有限公司  
CONNELY CONNELY ELECTRONIC CO. LTD