

REV.	DESCRIPTION	DRAWN	CHECKED	APPROVED
A	NEW RELEASE	WPY 03/06/26'		



Notes:

Specifications:

1. Contact Resistance: 20mΩ Max.
2. Insulation Resistance: 1000MΩ Min.
3. Dielectric Withstanding Voltage: 1000V AC(rms) For 1 Minute.
4. Current Rating:9A.
5. Voltage Rating:600V AC/DC.
6. Temperature: -25°C~+85°C.
7. Box size:19.5\*13\*3.6CM

Materials:

1. Contact Material: Copper Alloy.
2. Contact Plating: Tin Plated.
3. Insulator Materials: Nylon66,Transparent.

Product Number Code:

DS1073-02-BOX-01

GENERAL TOLERANCE		ANGLE TOLERANCE		PROJECTION		TITLE	370PCS 4.2mm Connector Crimp Type
X.	±0.30	X.	±2°	UNITS	mm		
.X	±0.20	.X	±1°	SHEET SIZE	A4	SERIES	DS1073-02 Series
.XX	±0.15	.XX	±0.5°	晨翔电子有限公司 <b>CONNFLY CONNFLY ELECTRONIC CO. LTD</b>			
DRAWING TYPE		CUSTOMER DRAWING					
SCALE	1:1	SHEET	1 OF 3				
DRAWING NO.		C-DS1073-02-BOX-01-A					

REV.	DESCRIPTION	DRAWN	CHECKED	APPROVED
A	NEW RELEASE	WPY 03/06/26'		

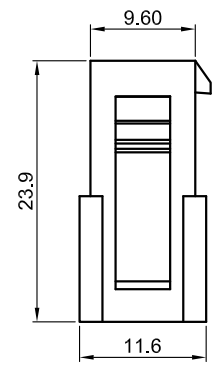
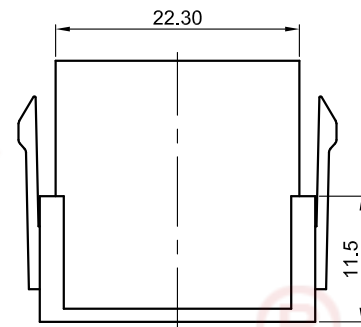
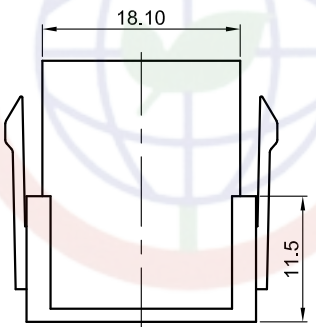
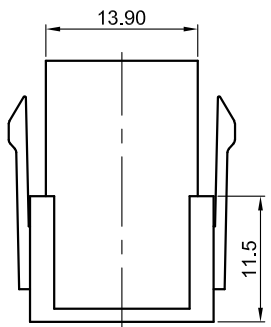
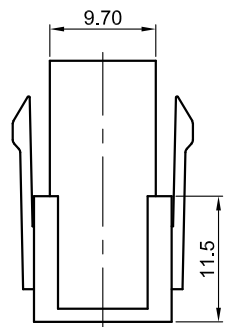
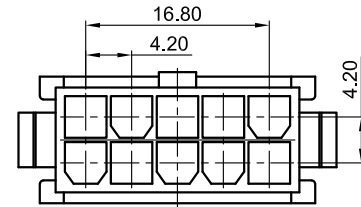
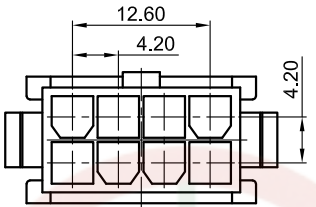
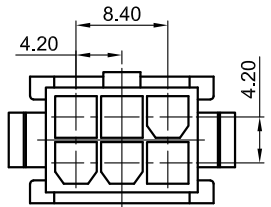
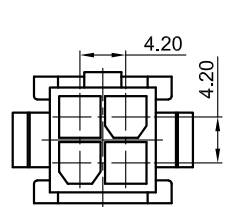

2Pin Male V/T Type

3Pin Male V/T Type

4Pin Male V/T Type

5Pin Male V/T Type

Male contact

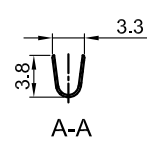
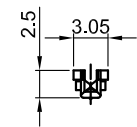
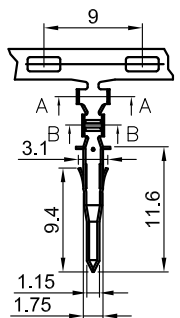
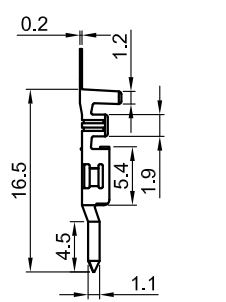

GENERAL TOLERANCE		ANGLE TOLERANCE	
X.	±0.30	X.	±2°
.X	±0.20	.X	±1°
.XX	±0.15	.XX	±0.5°

PROJECTION	TITLE
	4.2mm Connector Crimp Type
UNITS	mm
SHEET SIZE	A4
SERIES	DS1073-02 Series

DRAWING TYPE	CUSTOMER DRAWING
SCALE	1:1
DRAWING NO.	C-DS1073-02-BOX-01-A

晨翔电子有限公司  
**CONNFly CONNFly ELECTRONIC CO. LTD**

REV.	DESCRIPTION	DRAWN	CHECKED	APPROVED
A	NEW RELEASE	WPY 03/06/26'		

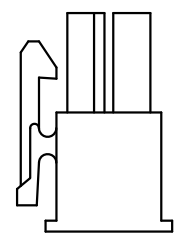
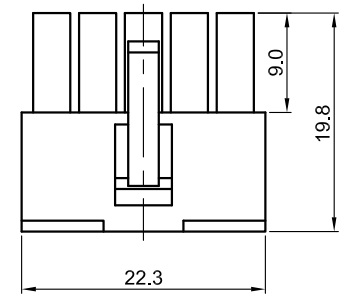
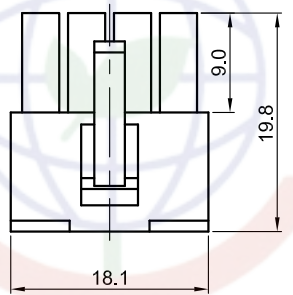
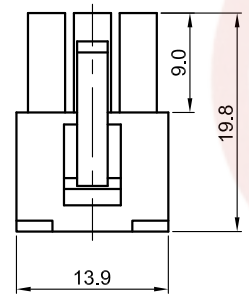
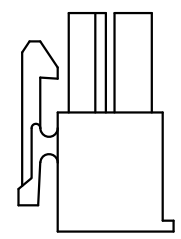
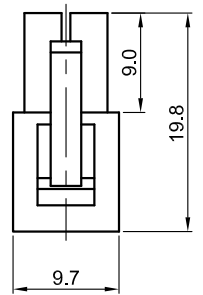
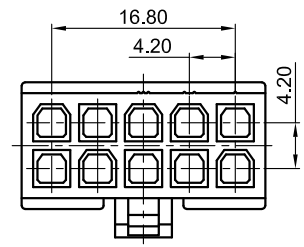
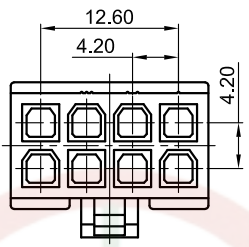
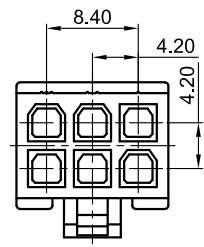
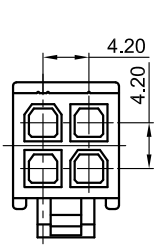

2Pin Female housing

3Pin Female housing

4Pin Female housing

5Pin Female housing

Female contact

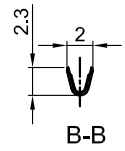
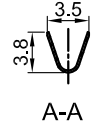
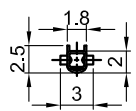
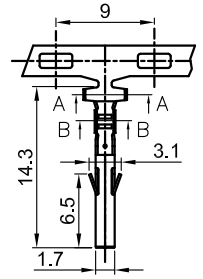
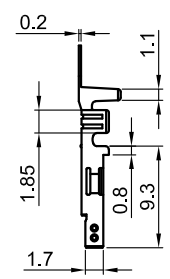

GENERAL TOLERANCE		ANGLE TOLERANCE	
X.	±0.30	X.	±2°
.X	±0.20	.X	±1°
.XX	±0.15	.XX	±0.5°

PROJECTION	TITLE
UNITS	4.2mm Connector Crimp Type
SHEET SIZE	SERIES DS1073-02 Series

DRAWING TYPE	CUSTOMER DRAWING
SCALE	1:1 SHEET 3 OF 3
DRAWING NO.	C-DS1073-02-BOX-01-A

**晨翔电子有限公司**  
**CONNFLY CONNFLY ELECTRONIC CO. LTD**